







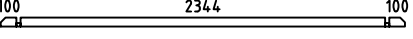
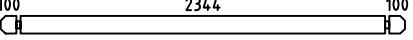
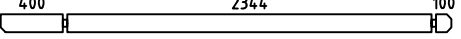
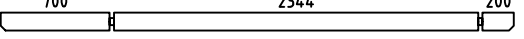
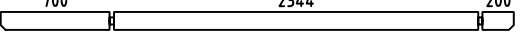
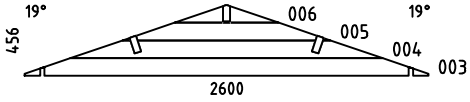
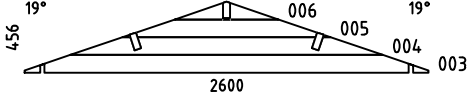
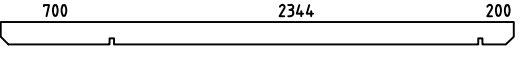
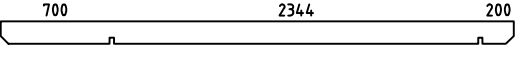

Gitte28

Pos	Specification-Spezifikation-Specificatie-Nomenclature-Elementi-Especificacion Gitte28	Qty	Profile (mm)	Lenght (mm)
001		2	28x57	495
002		32	28x114	495
007		1	28x57	2600
008		46	28x114	2600
009		2	28x114	2900
010		1	28x114	3300
011		1	28x114	3300
W1-1		1		
W2-1		1		
PL1	PURLIN-DAKBALK-DACHPFETTE-PANNE-ARCARECCIO-CORREA 	2	44x144	3300
PL2	PURLIN-DAKBALK-DACHPFETTE-PANNE-ARCARECCIO-CORREA 	1	44x144	3300
R-1	Roof board-Dachbrett-Dakplank-Volige-Tavola tetto-Tabla de tejado 	76+1 58+1	88x18 114x18	1490
GB-1	Gable board 95-Giebelblende-Gevelplank-Planche de rive-Tavola di bordo-Tabla de borde 	2	18x95	3300
GB-1	Gable board 120-Giebelblende-Gevelplank-Planche de rive-Tavola di bordo-Tabla de borde 	4	18x120	1530
RL-1	Roofing lath 2000-Giebelleiste-Gevellijst-Latte de rive-Listello di bordo-Listones de borde 	4	18x40	8rmt.
D	Diamond 	2		
	Double door kit-Doppeltür satz-Dubbele deur set-Kit double porte-Kit porta-Kit para puerta 	1		
	Nail 1.6x30-Nagel-Spijker-Clou-Chiodo-Clavo 	10	1.6x30	
Kood	Gitte28	Materjal	File	Gitte28.dwg
			Leht	1/2



Model	Gitte28	Page
Drawing	PLAN	Scale 1:20
Paper size	2.8x11.4	Date 29.11.2022
File	Gitte28.dwg	Drawn by

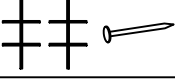
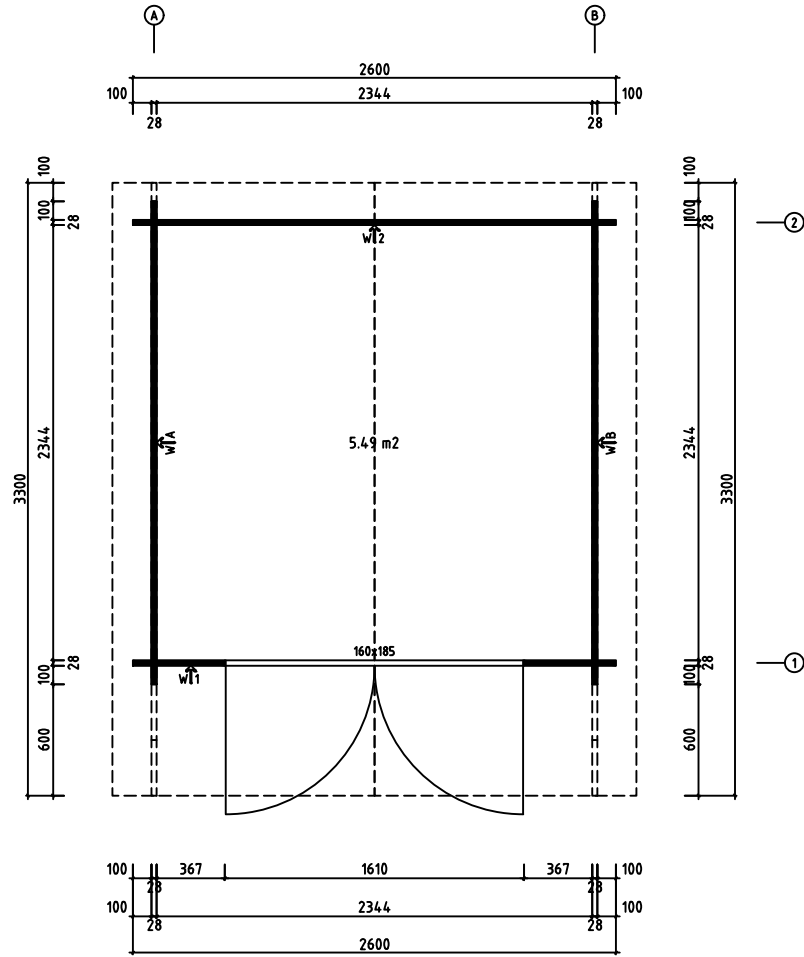
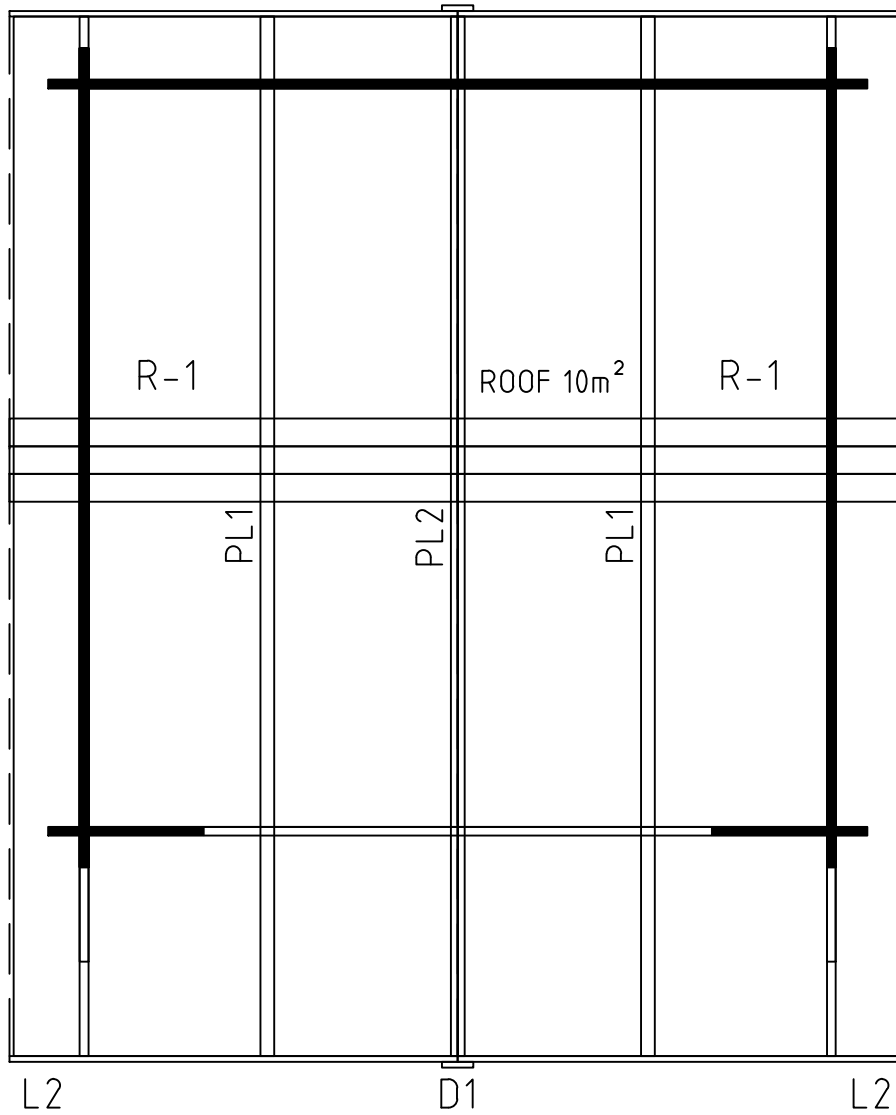

Model	Gitte28	Page
Drawing	ROOF	Scale 1:20
Material	2.8x11.4	Date 29.11.2022
File	Gitte28.dwg	Drawn by

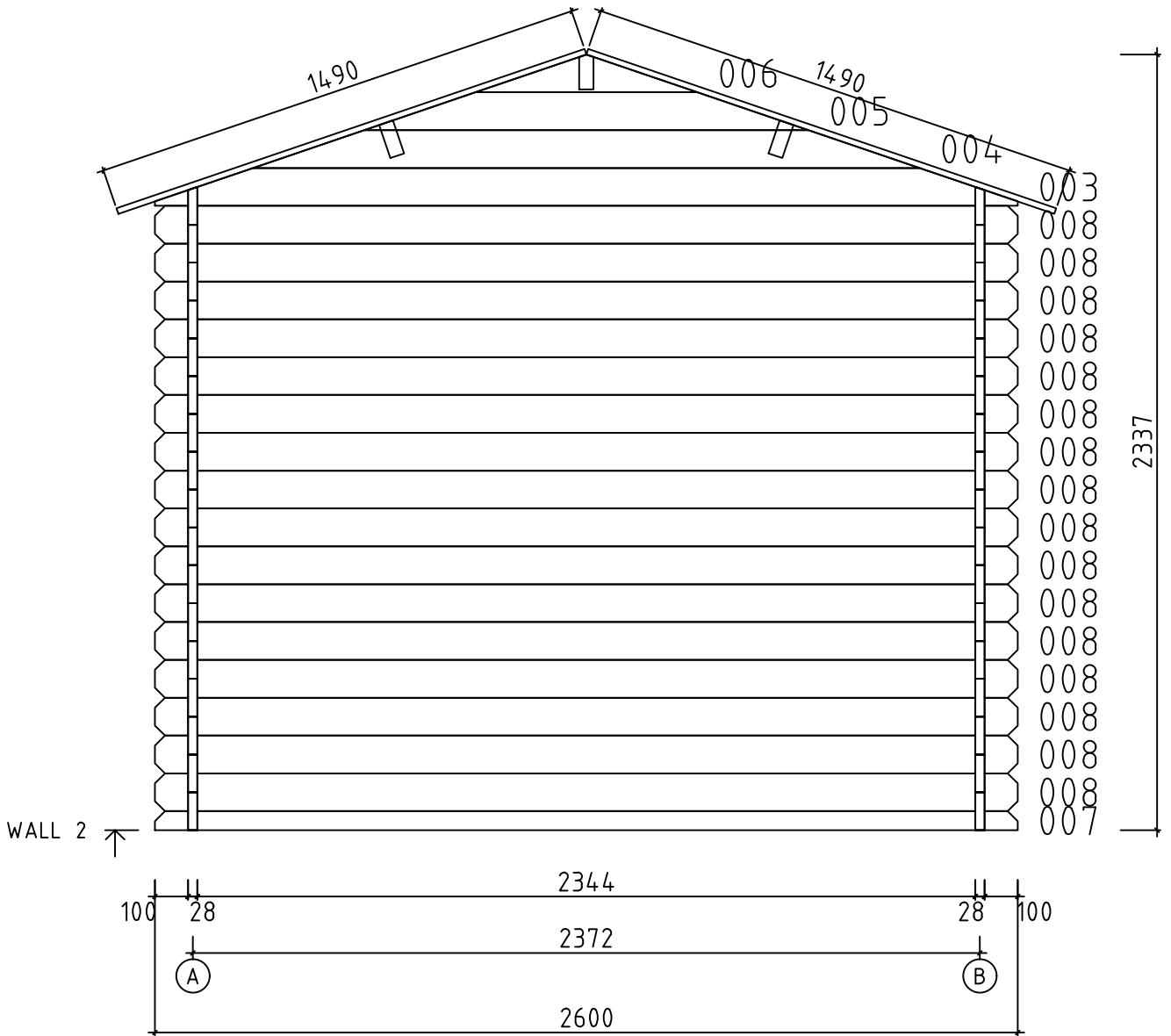

Model	Gitte28	Page	5
Drawing	WALL 2	Scale	1:20
Material	2.8x11.4	Date	29.11.2022
File	Gitte28.dwg	Drawn by	

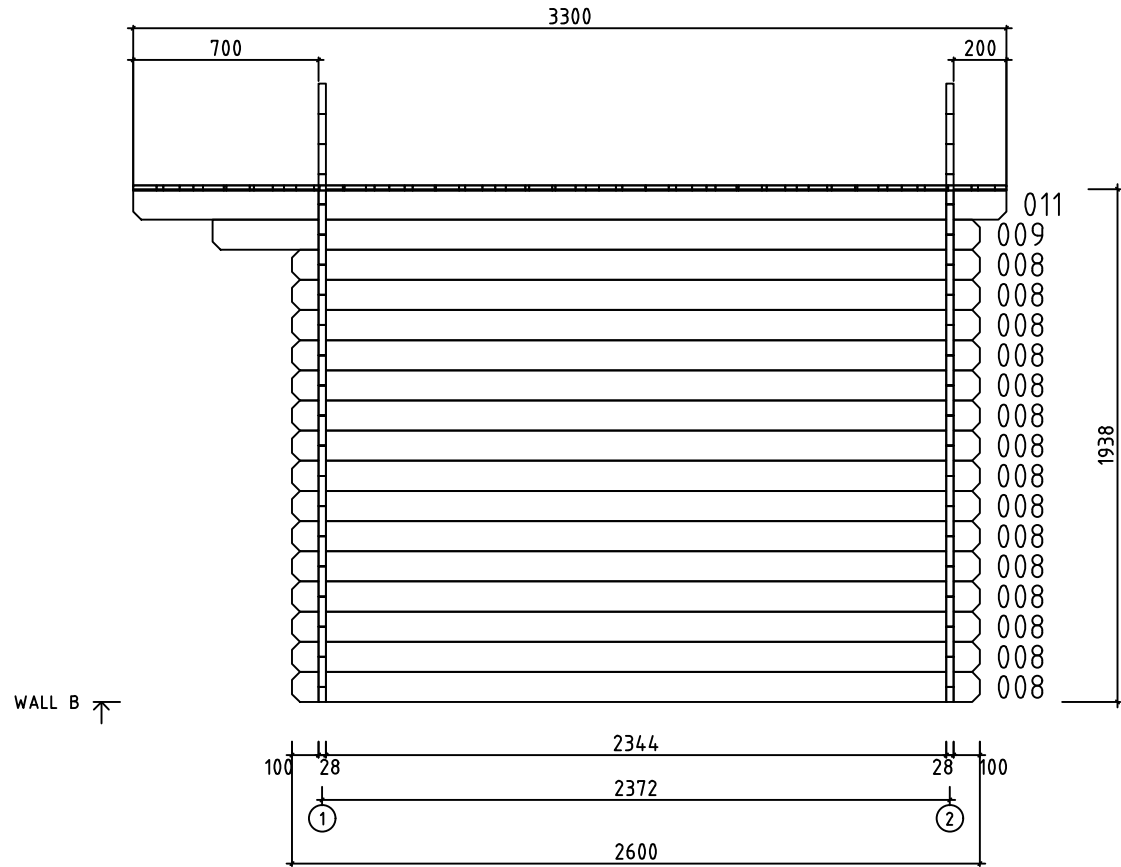

Model	Gitte28	Page	3
Drawing	WALL B	Scale	1:20
Material	2.8x11.4	Date	29.11.2022
File	Gitte28.dwg	Drawn by	

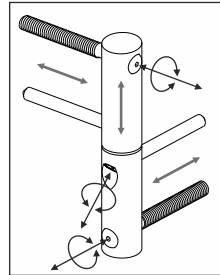
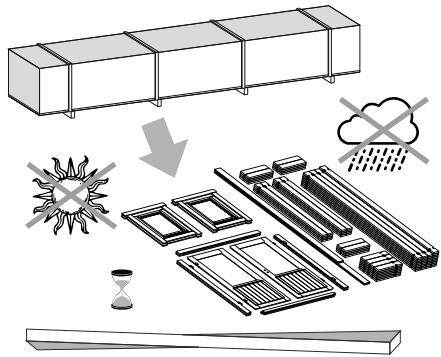
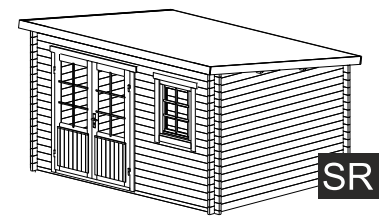
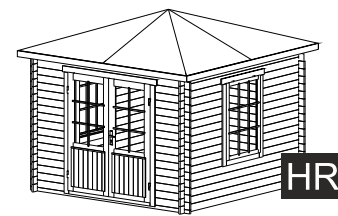
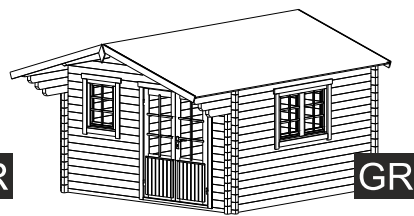
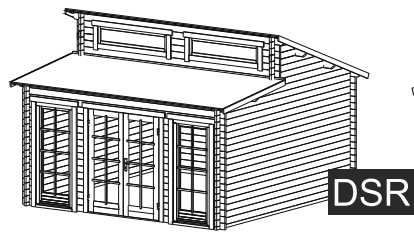
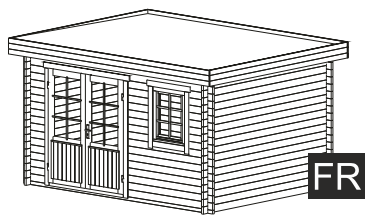

3.

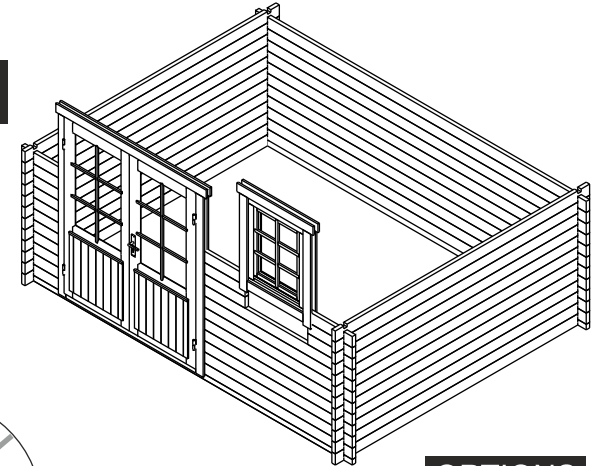

1.

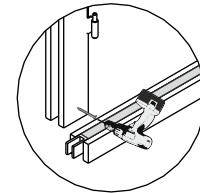
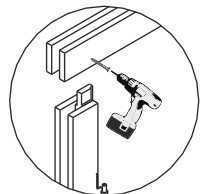
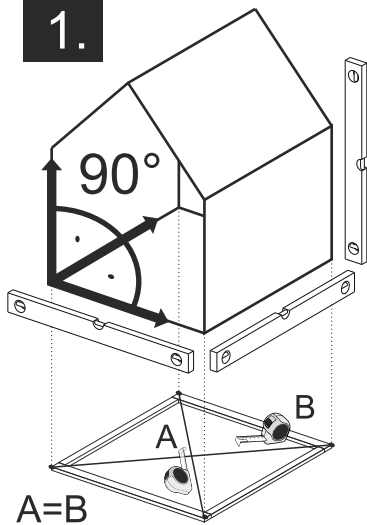

2.

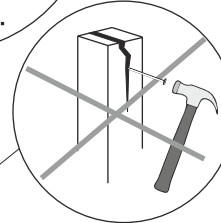
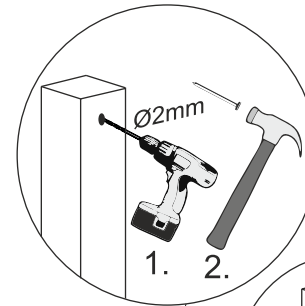
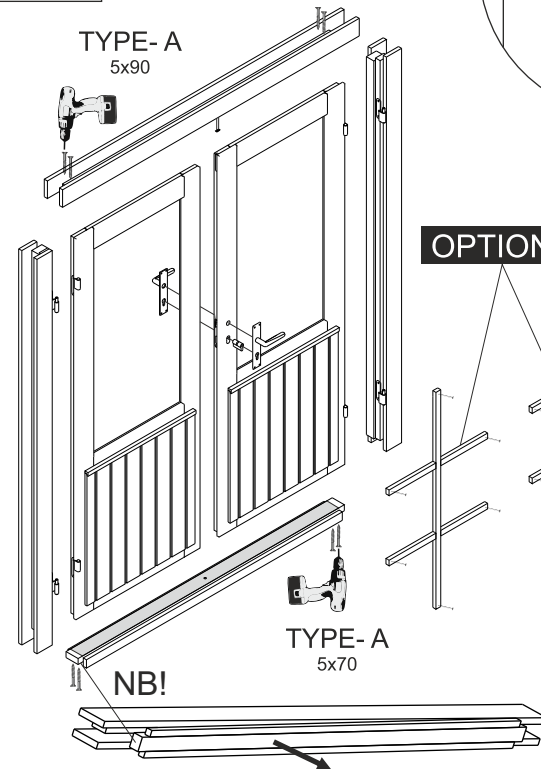

OPTIONS

4.

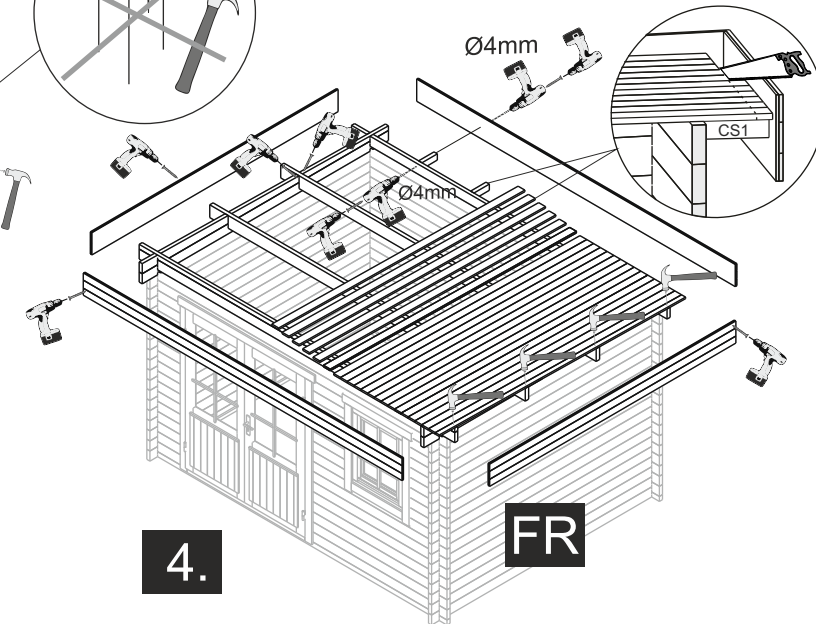

The guide is illustrative. This guide is not project specification.
Der Leitfaden ist illustrativ. Dieser Leitfaden ist keine Projektspezifikation.
De gids is illustratief. Deze gids is geen projectspecificatie.

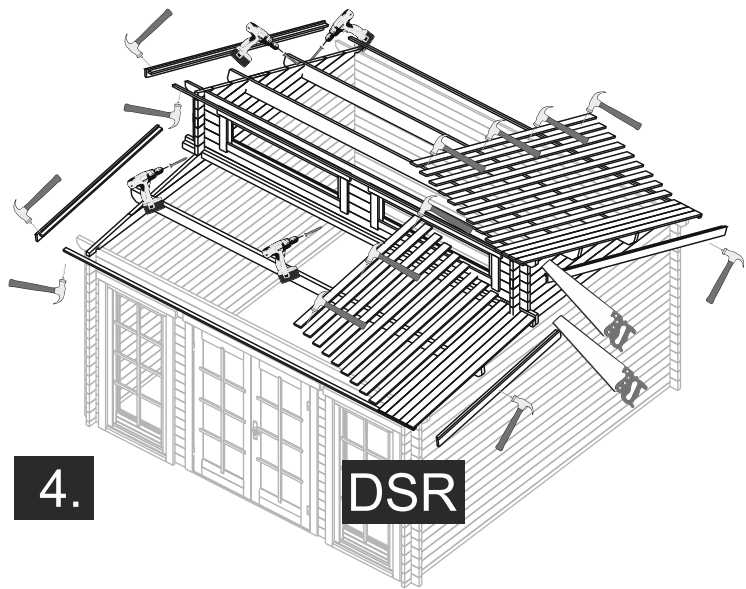

DSR

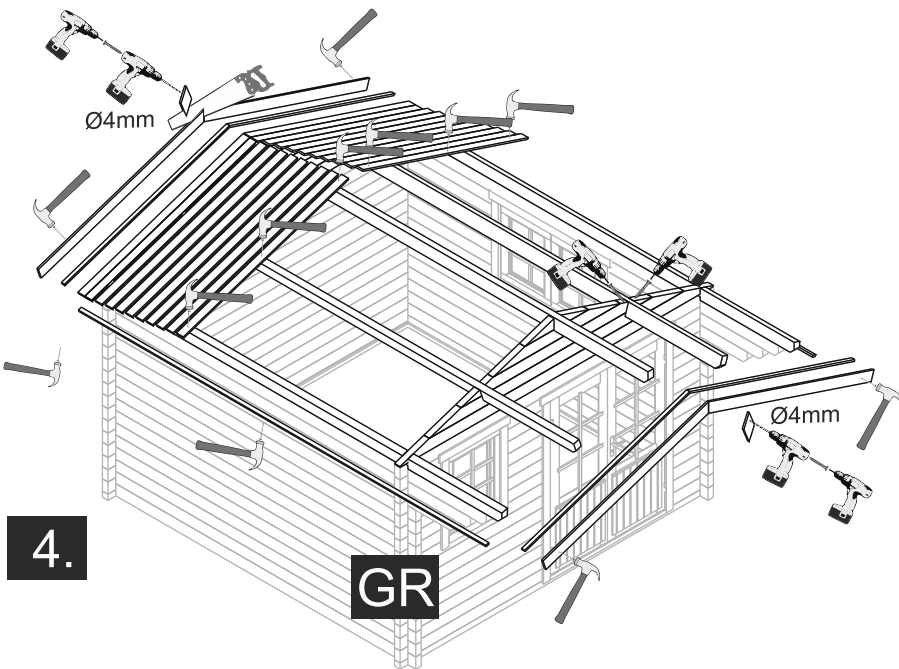

GR

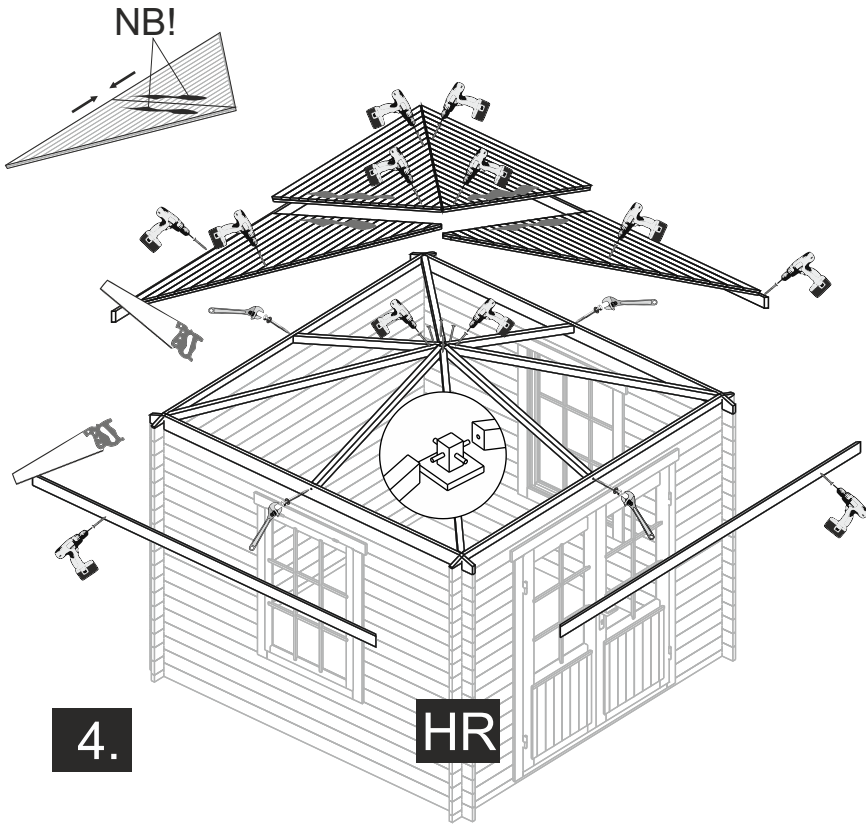

HR

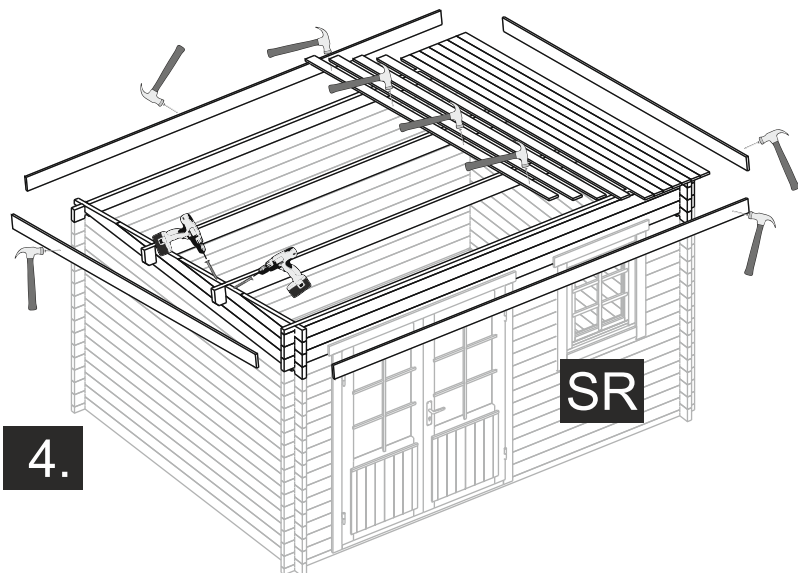

SR

OPTIONS

